

Selection diagram

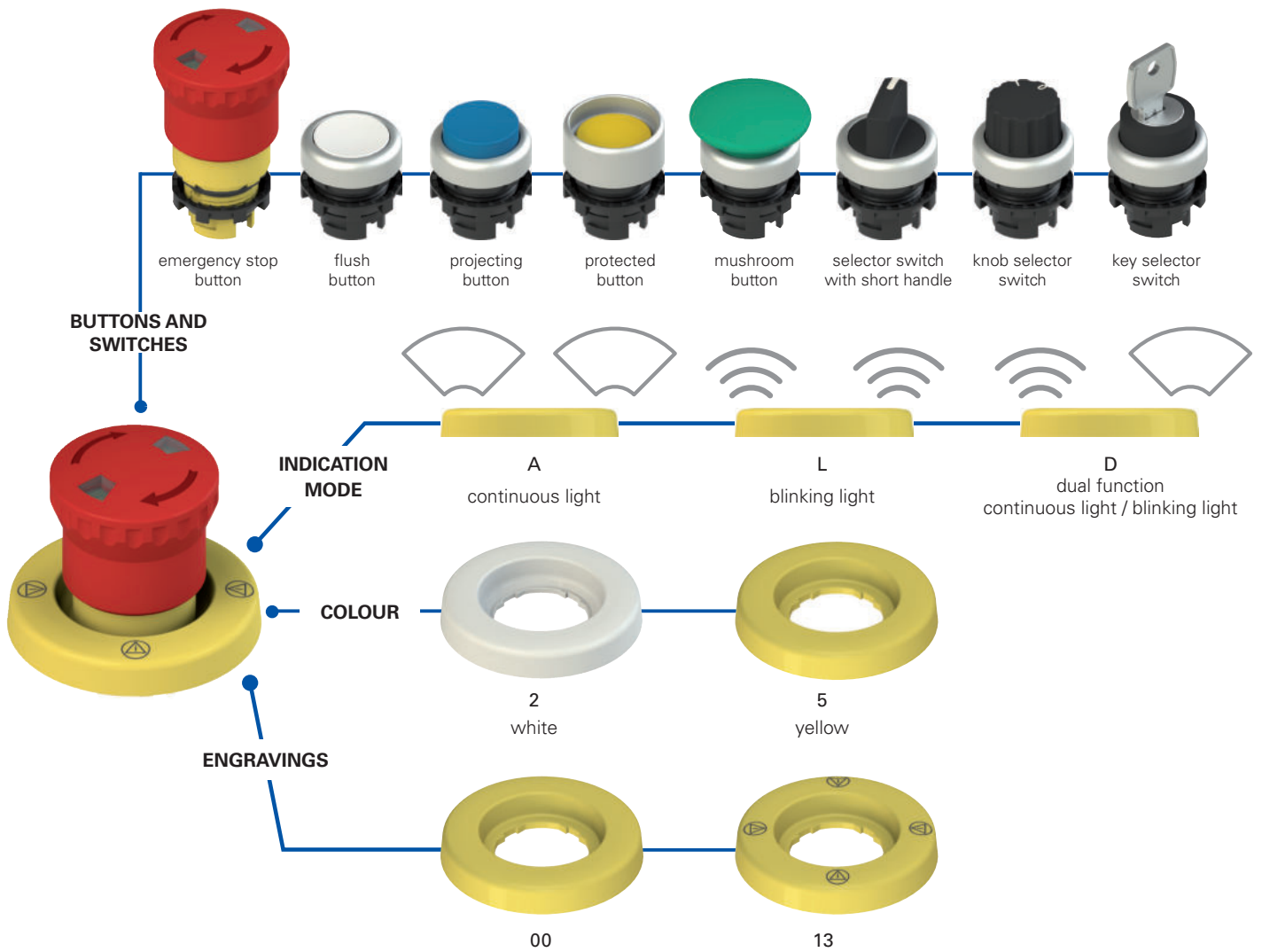

Code structure

Attention! The feasibility of a code number does not mean the effective availability of a product. Please contact our sales office.

VE DL1A5A00

Supply voltage	
1	24 Vac/dc
5	12 Vac/dc

Colour	
2	white
5	yellow

Engraving	
00	without engraving
13	with engraving: 
Other engravings on request.	

Indication mode	
A	continuous light
L	blinking light
D	dual function continuous light / blinking light



Main features

- High visibility
- Protection degree IP67
- Compact design
- Indelible laser engraving
- Customisable engravings
- Continuous, blinking or dual function light

Quality marks:



EAC approval: RU C-IT.YT03.B.00035/19

Technical data

General data

Protection degree:	IP67 acc. to EN 60529 (applied with the supplied adhesive)
Ambient temperature:	-25°C ... +70°C
Cable cross section:	0.25 mm ² (AWG 24)
Cable laying:	fixed
Cable minimum bending radius:	14 mm
Cable insulation:	PVC
Operating voltage U _e :	12 Vac/dc or 24 Vac/dc
Operating voltage tolerance:	±15% of U _e
Operating current at U _e voltage:	65 mA (12 Vac/dc version) 25 mA (24 Vac/dc version)
Blinking frequency (if present):	1 Hz
Utilization requirements:	See page 163

In compliance with standards:

IEC 60947-1, IEC 60947-5-1, IEC 60204-1, EN 60947-1, EN 60947-5-1, EN 60204-1, EN IEC 63000.

Compliance with the requirements of:

Low Voltage Directive 2014/35/EU,
EMC Directive 2014/30/EU,
RoHS Directive 2011/65/EU.

General data

Continuous or blinking light



The luminous disc can be supplied with two different lighting modes: continuous or blinking light. The blinking light versions allow a faster identification on the panel of

the lit device compared to the continuous light. The internal electronic circuit autonomously alternates the ON and OFF phases without requiring any special electrical connection.

Dual function luminous disc



This version of the luminous disc enables the device to be lit with a continuous or blinking light using a simple wiring system. The dual function luminous disc is fitted with three wires: depending on the

electrical connection, the light can be continuous or blinking.

Sticking

The luminous disc can also be installed using the supplied adhesive: simply remove the adhesive protective film placed under the disc. Thanks to this sticking, it is possible to get the perfect adhesion to the surface and the IP67 protection degree.

Customisable



In order to satisfy various customer requests and demands, Pizzato Elettrica offers the possibility to customize the luminous discs with engravings that are extremely visible thanks to the uniform lightning of the device.

High visibility

Thanks to internal high luminosity LEDs the emergency stop button can be immediately recognized and located. This ensures a safer use in scarcely illuminated environments, or when the device is placed at distance, or in case of scarce visibility.

The ideal way to highlight also normal buttons or selectors.

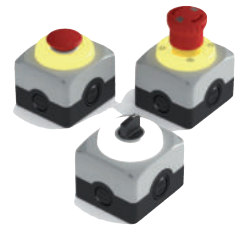

Protection degree IP67







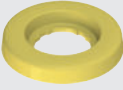

IP67 These devices are designed to be used in the toughest environmental conditions and they pass the IP67 immersion test acc. to EN 60529. They can therefore be used in all environments where maximum protection degree of the housing is required.

White lens version



The luminous disc can be purchased in the version with white lens and in the standard version with yellow lens. The white lens enables the luminous disc to make use of new signalling possibilities and also allows the device to be used as a point of light. The white lens version can also be personalised by way of laser engraving.

Selection table

Colour and engraving	Description	Type	Operating voltage	
			12 Vac/dc	24 Vac/dc
	Yellow luminous disc, Ø 60 mm, without engraving, acc. to ISO 13850	continuous light	VE DL5A5A00	VE DL1A5A00
		blinking light	VE DL5A5L00	VE DL1A5L00
		dual function	VE DL5A5D00	VE DL1A5D00
	Yellow luminous disc, Ø 60 mm, with engraving:  acc. to ISO 13850	continuous light	VE DL5A5A13	VE DL1A5A13
		blinking light	VE DL5A5L13	VE DL1A5L13
		dual function	VE DL5A5D13	VE DL1A5D13
	Yellow luminous disc, Ø 60 mm, with engraving: STOP  STOP  STOP  STOP 	continuous light	VE DL5A5A09	VE DL1A5A09
		blinking light	VE DL5A5L09	VE DL1A5L09
		dual function	VE DL5A5D09	VE DL1A5D09

To purchase the white luminous disc replace number 5 with number 2 in the codes shown above. Example: VE DL1A5A00 → VE DL1A2A00

Electrical connection of the dual function luminous disc



Cable colour	Description
white (J1)	Blinking light power supply
grey (J2)	Power supply 0 V
yellow (J3)	Continuous light power supply

Application example of the dual function luminous disc

It is possible to obtain a continuous or blinking light device depending on the wiring. For example, this opportunity can be exploited on a series of emergency stop buttons connected in chain formation (figure 1). The luminous disc can pass from the continuous light mode to the blinking light mode when the respective emergency stop button is pressed: this way the luminous disc of the selected emergency stop button begins to blink while all the others switch off, making it easy to identify the point where the emergency stop button was pressed (figure 2).

Figure 3 indicates an example of the electrical diagram for the connection in series of three or more emergency stop buttons fitted with dual function luminous disc.

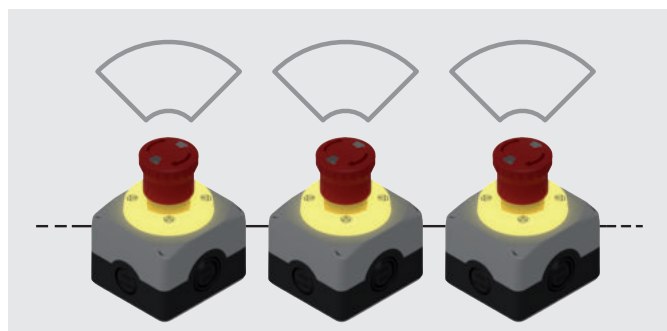

Figure 1

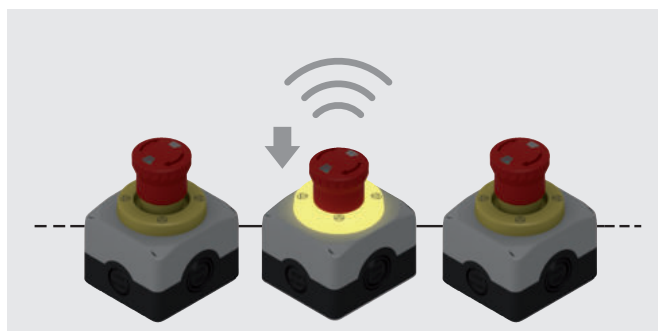

Figure 2

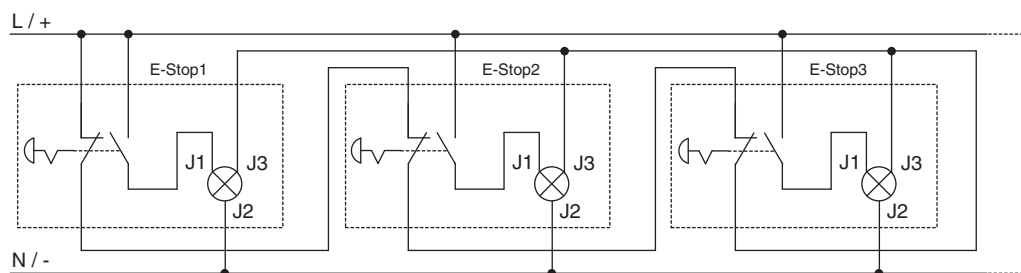
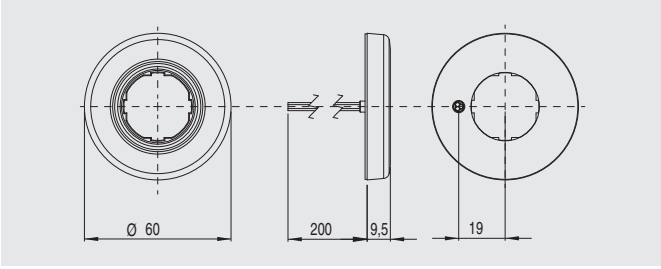
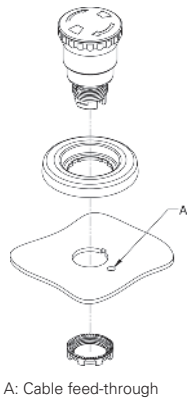
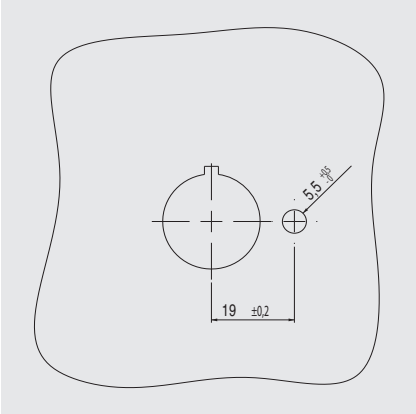

Figure 3

Dimensions



Drilling and mounting



A: Cable feed-through

Minimum distances for installation

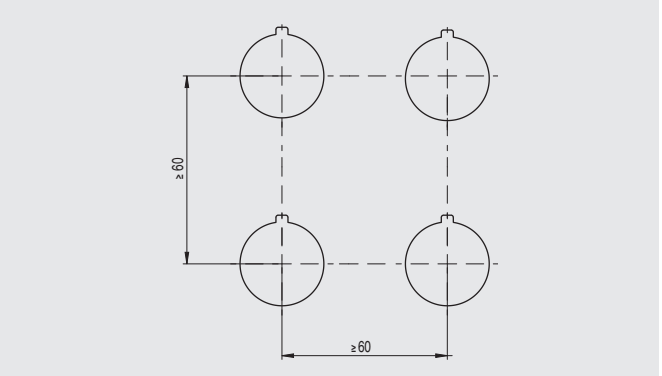

All values in the drawings are in mm

Connection block Packs of 10 pcs.



Connection blocks without electrical contacts and dimensions identical to those of the contact blocks. Fitted with two electrically separated terminals to enable the VE DL series luminous disc to be installed without any additional terminals or crimp connections.

Article	Description
VE BC2PV1	Connection block with 2 terminals on a panel
VE BC2FV1	Connection block with 2 terminals on a base mounting



Traditional wiring

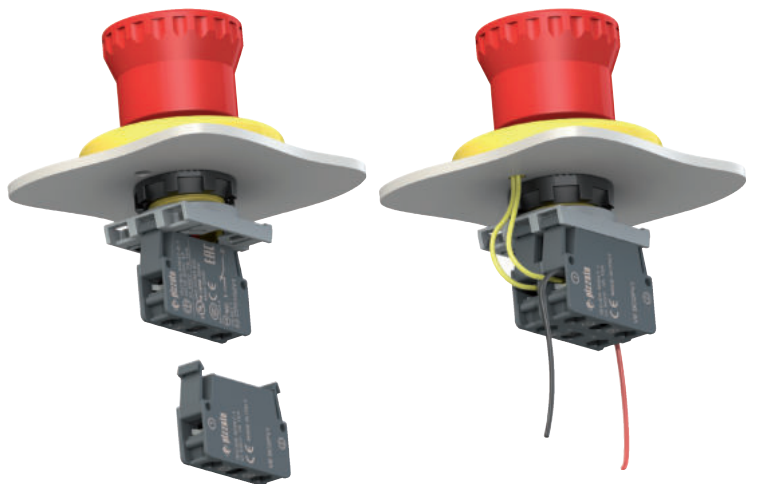

Wiring with connection block

Accessories

→ More ACCESSORIES on page 155