



**Joystick  
E2 MA series**



EROUND

## Selection diagram

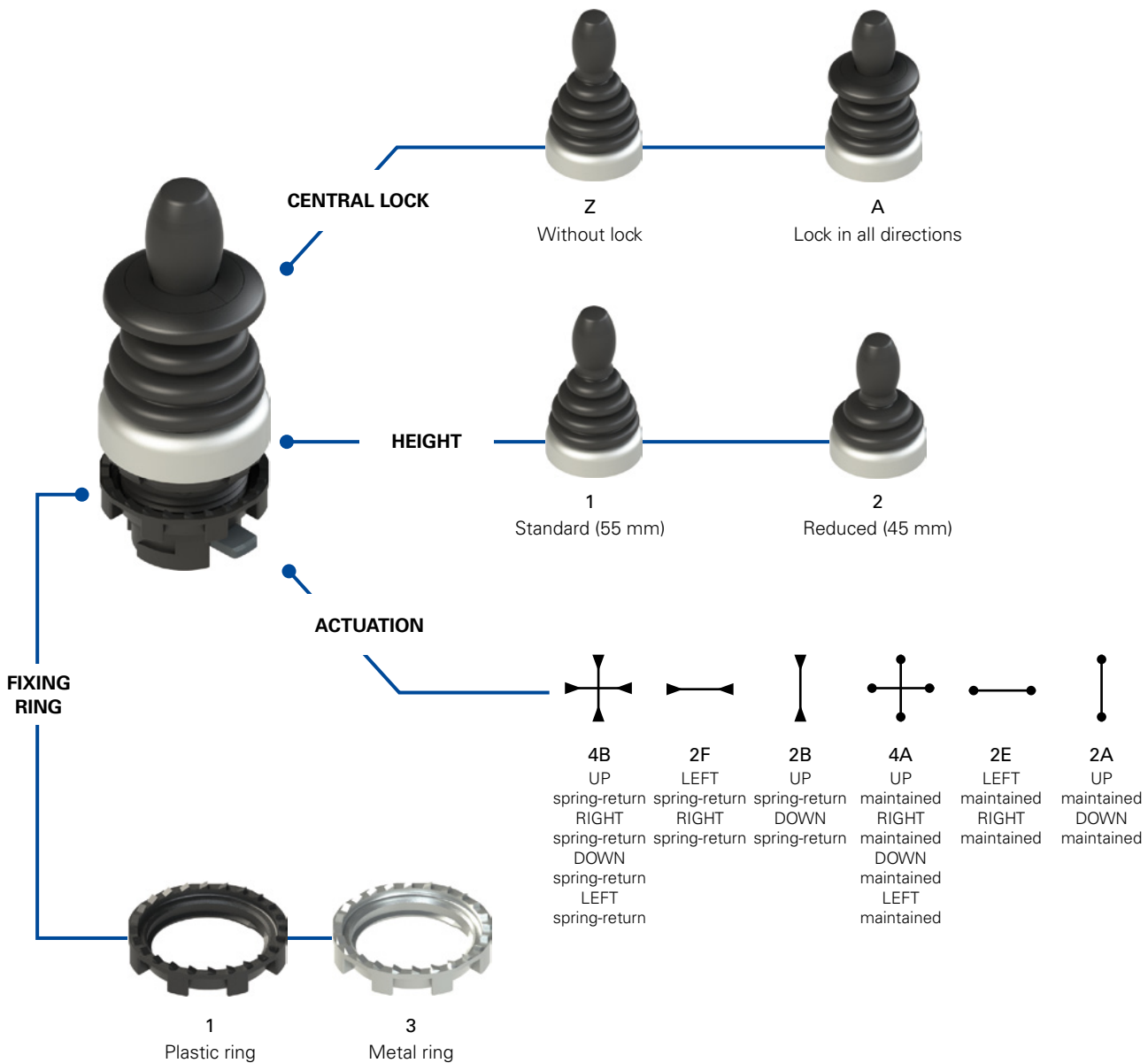

### Code structure

**Attention!** The feasibility of a code number does not mean the effective availability of a product. Please contact our sales office.

## E2 1MA14BZ91

#### Fixing ring and shaped ring

1	plastic ring (standard)
2	plastic fixing ring and shaped ring
3	metal ring
4	metal fixing ring and shaped ring

#### Joystick height

1	standard (55 mm)
2	reduced (45 mm)

#### Lock

Z	without lock
A	lock in all directions

#### Actuation

4B	UP spring-return, RIGHT spring-return, DOWN spring-return, LEFT spring-return
2F	LEFT spring-return, RIGHT spring-return
2B	UP spring-return, DOWN spring-return
4A	UP maintained, RIGHT maintained, DOWN maintained, LEFT maintained
2E	LEFT maintained, RIGHT maintained
2A	UP maintained, DOWN maintained



**Technical data**

**General data**

Protection degree:	IP67 acc. to IEC 60529 IP69K acc. to ISO 20653
Ambient temperature:	-40°C ... +80°C
Mechanical endurance:	1 million operating cycles 500,000 unblocking operating cycles
Max. actuation frequency:	3600 operating cycles/hour
Actuating force:	0.17 Nm (spring-return actuation) 0.3 Nm (maintained actuation)
Maximum travel:	35°
Tightening torque of the fixing ring:	2 ... 2.5 Nm
Utilization requirements:	see page 124 of the general catalogue HMI 2015-2016

**Main features**

- Protection degrees IP67 and IP69K
- 2 possible heights: standard (55 mm) and reduced (45 mm)
- Versions with central lock
- Version with spring-return or maintained actuation
- Two-step actuation

**Markings and quality marks:**



EAC approval: RU C-IT DM94.B.01024

**In conformity with standards:**

IEC 60947-1, IEC 60947-5-1, IEC 60204-1, EN 60947-1, EN 60947-5-1, EN 60204-1, UL 508, CSA 22-2 no.14

**⚠ Installation with operator protection function:**

Use only contact blocks marked with the symbol ⊕. Always connect the safety circuit to the **NC contacts** (normally closed contacts: .1-2) as stated in standard EN 60947-5-1, encl. K, par. 2.

**Compliance with the requirements of:**

Low Voltage Directive 2014/35/EU  
EMC Directive 2014/30/EU

**Positive contact opening in conformity with standards:**

IEC 60947-5-1, EN 60947-5-1.

**General data**

**Protection degrees IP67 and IP69K**

**IP69K**  
**IP67**

The elastic hood of the Pizzato joystick is made in a single seamless piece that completely encloses the lever, in this way without leaving the minimum aperture or junction. This particular solution (patent pending), is present in all versions of the joystick, including the reduced height and central lock versions, and is the most effective method to ensure protection from any possible penetration of dirt and water; these devices can therefore be used in all environments in which the highest degree of protection of the casing is required, and they pass both the IP67 immersion test acc. to IEC 60529 and the IP69K test acc. to ISO 20653 with jets of water at 100 atmospheres and 80°C temperature, thereby permitting their use also in machines which undergo washing with high-pressure jets of hot water.

**Two-step actuation**

The Pizzato Elettrica E2 MA series joystick combines a rich set of features and options in a compact and ergonomic shape. Among these is the possibility to obtain two-step actuation in any direction: it is sufficient to connect an additional NO contact block with early make contacts in series to the normal NO contact block. This option can be used for example to control two-speed actuations in the same direction.

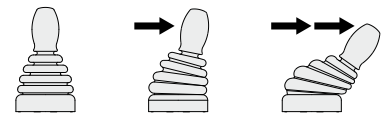

**Maintained or spring-return actuation**

Versions with 2 or 4 directions are available, and the single directions can have a maintained actuation, in which the lever remains in the tilted position, or spring-return actuation, in which the lever automatically returns to the central position.

**Central lock**

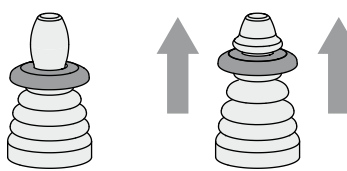
 To prevent accidental operation, the E2 MA series joystick can be ordered in versions with central locking. In these versions the lever remains fixed in the central position and can be steered in the various directions only after being unlocked by simply pulling the release disk. The pulling release movement avoids unwanted unlocking actions.

**Two compact forms**

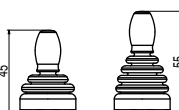
 With the standard height version (55mm), there is also a reduced height (45 mm) version, ideal for all situations where a low height is required. Even so, the low height version of the joystick does not dispense with any of the standard version options, such as the possibility of being provided with central lock.

**Easy configuration of the contacts**

The joystick is paired with a mounting adapter with four slots, thus allowing to associate different types of contact blocks to every single direction of actuation. Single or double contact blocks, even on two levels, can be used. There are therefore no constraints on the type of contact block, the users can freely install the standard contact block in the configuration they prefer.



**Plates for the joystick**

 The joystick can be paired with specific circular and rectangular plates. This accessory, available in black or grey colour, is the ideal complement for the joystick at both the functional and aesthetic level, creating an assembly of original and elegant design. The plates specify with clear indications the functions performed by the joystick, and can be customised with symbols or written text. The laser-engraved markings are indelible. The application of the plate does not alter the IP protection degree of the device.

## Selection table



Functions		Standard height (55 mm) without lock	Standard height (55 mm) with lock	Reduced height (45 mm) without lock	Reduced height (45 mm) with lock
		Satin chrome bezel	Satin chrome bezel	Satin chrome bezel	Satin chrome bezel
	UP spring-return, RIGHT spring-return, DOWN spring-return, LEFT spring-return	E2 1MA14BZ91	E2 1MA14BA91	E2 1MA24BZ91	E2 1MA24BA91
	LEFT spring-return, RIGHT spring-return	E2 1MA12FZ91	E2 1MA12FA91	E2 1MA22FZ91	E2 1MA22FA91
	UP spring-return, DOWN spring-return	E2 1MA12BZ91	E2 1MA12BA91	E2 1MA22BZ91	E2 1MA22BA91
	UP maintained, RIGHT maintained, DOWN maintained, LEFT maintained	E2 1MA14AZ91	E2 1MA14AA91	E2 1MA24AZ91	E2 1MA24AA91
	LEFT maintained, RIGHT maintained	E2 1MA12EZ91	E2 1MA12EA91	E2 1MA22EZ91	E2 1MA22EA91
	UP maintained, DOWN maintained	E2 1MA12AZ91	E2 1MA12AA91	E2 1MA22AZ91	E2 1MA22AA91

## Selection table for complete units



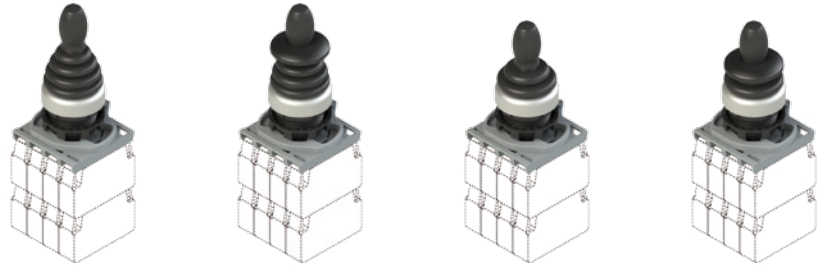

Functions		Contacts				Standard height (55 mm) without lock	Standard height (55 mm) with lock	Reduced height (45 mm) without lock	Reduced height (45 mm) with lock
		pos. 3	pos. 2	pos. 4	pos. 1	Satin chrome bezel	Satin chrome bezel	Satin chrome bezel	Satin chrome bezel
	UP spring-return, RIGHT spring-return, DOWN spring-return, LEFT spring-return	1NO	1NO	1NO	1NO	E2 AC-DXBC2602 E2 1MA14BZ91 + E2 1BAC21 + 4x E2 CP10G2V1	E2 AC-DXBC2604 E2 1MA14BA91 + E2 1BAC21 + 4x E2 CP10G2V1	E2 AC-DXBC2603 E2 1MA24BZ91 + E2 1BAC21 + 4x E2 CP10G2V1	E2 AC-DXBC2605 E2 1MA24BA91 + E2 1BAC21 + 4x E2 CP10G2V1
	LEFT spring-return, RIGHT spring-return	1NO			1NO	E2 AC-DXBC2601 E2 1MA12FZ91 + E2 1BAC21 + 2x E2 CP10G2V1	E2 AC-DXBC2613 E2 1MA12FA91 + E2 1BAC21 + 2x E2 CP10G2V1	E2 AC-DXBC2618 E2 1MA22FZ91 + E2 1BAC21 + 2x E2 CP10G2V1	E2 AC-DXBC2622 E2 1MA22FA91 + E2 1BAC21 + 2x E2 CP10G2V1
	UP spring-return, DOWN spring-return		1NO	1NO		E2 AC-DXBC2600 E2 1MA12BZ91 + E2 1BAC21 + 2x E2 CP10G2V1	E2 AC-DXBC2611 E2 1MA12BA91 + E2 1BAC21 + 2x E2 CP10G2V1	E2 AC-DXBC2616 E2 1MA22BZ91 + E2 1BAC21 + 2x E2 CP10G2V1	E2 AC-DXBC2620 E2 1MA22BA91 + E2 1BAC21 + 2x E2 CP10G2V1
	UP maintained, RIGHT maintained, DOWN maintained, LEFT maintained	1NO	1NO	1NO	1NO	E2 AC-DXBC2608 E2 1MA14AZ91 + E2 1BAC21 + 4x E2 CP10G2V1	E2 AC-DXBC2614 E2 1MA14AA91 + E2 1BAC21 + 4x E2 CP10G2V1	E2 AC-DXBC2609 E2 1MA24AZ91 + E2 1BAC21 + 4x E2 CP10G2V1	E2 AC-DXBC2623 E2 1MA24AA91 + E2 1BAC21 + 4x E2 CP10G2V1
	LEFT maintained, RIGHT maintained	1NO			1NO	E2 AC-DXBC2607 E2 1MA12EZ91 + E2 1BAC21 + 2x E2 CP10G2V1	E2 AC-DXBC2612 E2 1MA12EA91 + E2 1BAC21 + 2x E2 CP10G2V1	E2 AC-DXBC2617 E2 1MA22EZ91 + E2 1BAC21 + 2x E2 CP10G2V1	E2 AC-DXBC2621 E2 1MA22EA91 + E2 1BAC21 + 2x E2 CP10G2V1
	UP maintained, DOWN maintained		1NO	1NO		E2 AC-DXBC2606 E2 1MA12AZ91 + E2 1BAC21 + 2x E2 CP10G2V1	E2 AC-DXBC2610 E2 1MA12AA91 + E2 1BAC21 + 2x E2 CP10G2V1	E2 AC-DXBC2615 E2 1MA22AZ91 + E2 1BAC21 + 2x E2 CP10G2V1	E2 AC-DXBC2619 E2 1MA22AA91 + E2 1BAC21 + 2x E2 CP10G2V1

**Selection table for complete units with two-step actuation**



Functions		Contacts				Standard height (55 mm) without lock	Standard height (55 mm) with lock	Reduced height (45 mm) without lock	Reduced height (45 mm) with lock
		pos. 3	pos. 2	pos. 4	pos. 1	Satin chrome bezel	Satin chrome bezel	Satin chrome bezel	Satin chrome bezel
	UP spring-return, RIGHT spring-return, DOWN spring-return, LEFT spring-return	1NO +	1NO +	1NO +	1NO +	<b>E2 AC-DXBC2626</b> E2 1MA14BZ91 + E2 1BAC21 + 4x E2 CP10G2V1 + 4x E2 CP10L2V1	<b>E2 AC-DXBC2629</b> E2 1MA14BA91 + E2 1BAC21 + 4x E2 CP10G2V1 + 4x E2 CP10L2V1	<b>E2 AC-DXBC2632</b> E2 1MA24BZ91 + E2 1BAC21 + 4x E2 CP10G2V1 + 4x E2 CP10L2V1	<b>E2 AC-DXBC2635</b> E2 1MA24BA91 + E2 1BAC21 + 4x E2 CP10G2V1 + 4x E2 CP10L2V1
	LEFT spring-return, RIGHT spring-return	1NO +			1NO +	<b>E2 AC-DXBC2625</b> E2 1MA12FZ91 + E2 1BAC21 + 2x E2 CP10G2V1 + 2x E2 CP10L2V1	<b>E2 AC-DXBC2628</b> E2 1MA12FA91 + E2 1BAC21 + 2x E2 CP10G2V1 + 2x E2 CP10L2V1	<b>E2 AC-DXBC2631</b> E2 1MA22FZ91 + E2 1BAC21 + 2x E2 CP10G2V1 + 2x E2 CP10L2V1	<b>E2 AC-DXBC2634</b> E2 1MA22FA91 + E2 1BAC21 + 2x E2 CP10G2V1 + 2x E2 CP10L2V1
	UP spring-return, DOWN spring-return		1NO +	1NO +		<b>E2 AC-DXBC2624</b> E2 1MA12BZ91 + E2 1BAC21 + 2x E2 CP10G2V1 + 2x E2 CP10L2V1	<b>E2 AC-DXBC2627</b> E2 1MA12BA91 + E2 1BAC21 + 2x E2 CP10G2V1 + 2x E2 CP10L2V1	<b>E2 AC-DXBC2630</b> E2 1MA22BZ91 + E2 1BAC21 + 2x E2 CP10G2V1 + 2x E2 CP10L2V1	<b>E2 AC-DXBC2633</b> E2 1MA22BA91 + E2 1BAC21 + 2x E2 CP10G2V1 + 2x E2 CP10L2V1

**Legend:**  
 maintained actuation  
 spring-return actuation

**Dimensions**

All measures in the drawings are in mm

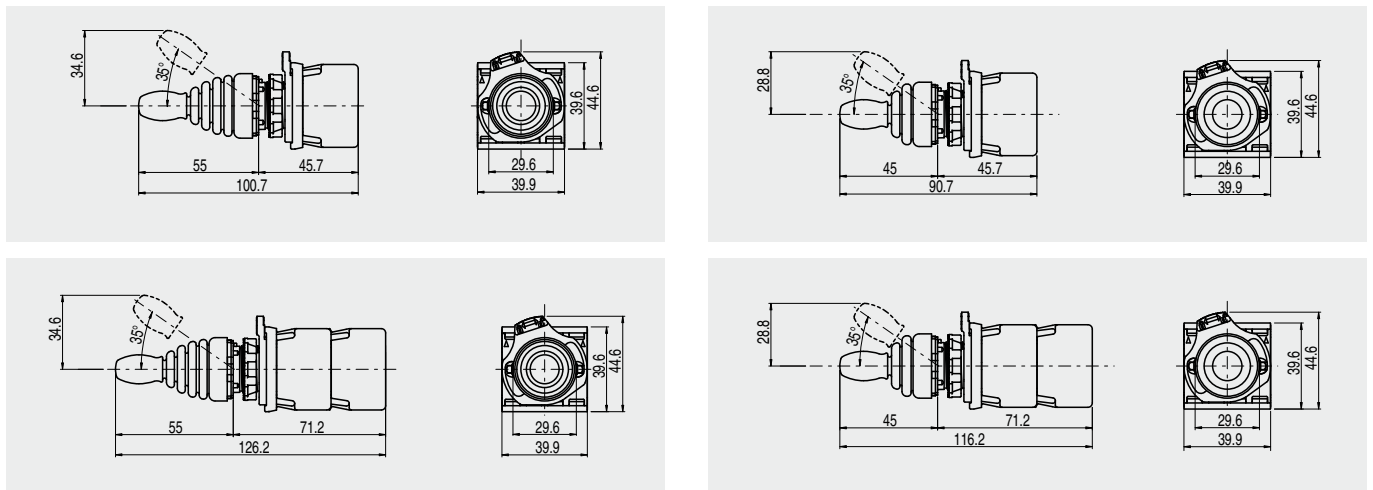

**Minimum distances for installation**

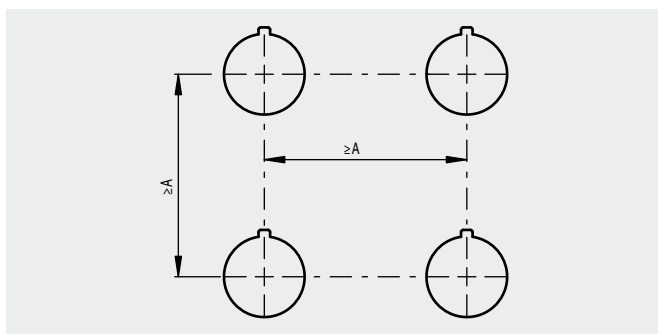

Standard height joystick  
A=70 mm

Reduced height joystick  
A=60 mm

→ The 2D and 3D files are available at [www.pizzato.com](http://www.pizzato.com)

## Maximum number of contact blocks

4-slot mounting adapter

Joystick E2 •MA••••••••

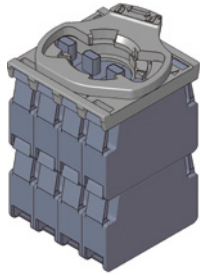

maximum number:  
8 contact blocks  
2 levels

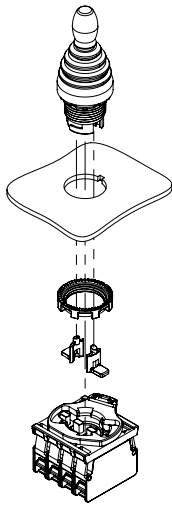

The assembly of the 2 lateral actuators, supplied with the joystick, must be done after the fixing of the joystick.

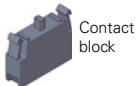

Contact block

## Mounting adapter

Packs of **10 pcs.**

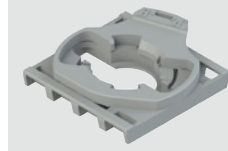

Article	Description
E2 1BAC21	4-slot mounting adapter for contact blocks E2 CP••••••••

## Shaped ring

Packs of **50 pcs.**



Article	Description
VE GP12H1A	Shaped ring for single device
Not applicable in the presence of the circular and rectangular plate, adapter from Ø 22 to Ø 30 mm or protection guard	

## Fixing ring

Packs of **20 pcs.**



Article	Description
VE GF720A	Metal fixing ring

## Single contact block

Packs of **10 pcs.**



## Double contact block

Packs of **5 pcs.**



Contact block	Panel mounting Screw connection
1NC, slow action →	E2 CP01G2V1 0 1.1 ⊕2.1 5
1NO, slow action	E2 CP10G2V1 0 2.5 5
1NC, slow action, delayed →	E2 CP01K2V1 0 2.5 ⊕3.5 5
1NO, slow action, early make	E2 CP10L2V1 0 1.5 5

Contact block	Panel mounting Screw connection
1NO+1NC, slow action →	E2 CP11G2V1 0 2.5 5 1.1 ⊕2.1
2NO, slow action	E2 CP20G2V1 0 2.5 5
2NC, slow action →	E2 CP02G2V1 0 1.1 ⊕2.1 5

**Attention:** The joystick cannot be used with the types of contact blocks designed for mounting at the housing bottom

→ The 2D and 3D files are available at [www.pizzato.com](http://www.pizzato.com)

Items with code on **green** background are stock items





### Plates with shaped hole

Suitable for devices E2 •MA••••••.

Can be oriented in 90° steps.

Upon request with different markings or inscriptions in other languages.

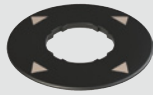
**It does not alter the IP67 / IP69K protection degree of the associated device.**

	Article	Description
	VE TF32A9133	Plate with shaped hole, circular, Ø 60 mm, grey, inscription: ▲   ▸   ▼   ◀
	VE TF12A1233	Plate with shaped hole, circular, Ø 60 mm, black, inscription: ▲   ▸   ▼   ◀
	VE TF32G9134	Plate with shaped hole, rectangular, 30x60 mm, grey, inscription: ▲   ▼
	VE TF12G1234	Plate with shaped hole, rectangular, 30x60 mm, black, inscription: ▲   ▼

	Article	Description
	VE TF32A9130	Plate with shaped hole, circular, Ø 60 mm, grey, inscription: UP ▲   R ▸   DOWN ▼   L ◀
	VE TF12A1230	Plate with shaped hole, circular, Ø 60 mm, black, inscription: UP ▲   R ▸   DOWN ▼   L ◀
	VE TF32G9131	Plate with shaped hole, rectangular, 30x60 mm, grey, inscription: UP ▲   DOWN ▼
	VE TF12G1231	Plate with shaped hole, rectangular, 30x60 mm, black, inscription: UP ▲   DOWN ▼
	VE TF32G9132	Plate with shaped hole, rectangular, 30x60 mm, grey, inscription: R ▸   L ◀
	VE TF12G1232	Plate with shaped hole, rectangular, 30x60 mm, black, inscription: R ▸   L ◀

### Windowed protection guard

	Article	Description
	VE GP32A5A	Cylindrical yellow protection guard with 4 windows Ø 40x20 mm

Suitable for reduced height joystick

**It does not alter the IP protection degree of the associated device.**

### Cylindrical protection guard

	Article	Description
	VE GP32B5A	Cylindrical yellow protection guard Ø 43x27 mm

Suitable for standard height joystick

**It does not alter the IP protection degree of the associated device.**

### Open protection guard

	Article	Description
	VE GP32F5A	Rectangular open yellow protection guard 66x38 mm, 35 mm high, complete with 4 screws (for panels of thickness from 1 to 3.5 mm)

Suitable for the two-direction, standard and reduced height joystick

**It does not alter the IP protection degree of the associated device.**

→ The 2D and 3D files are available at [www.pizzato.com](http://www.pizzato.com)

### Application examples of guards

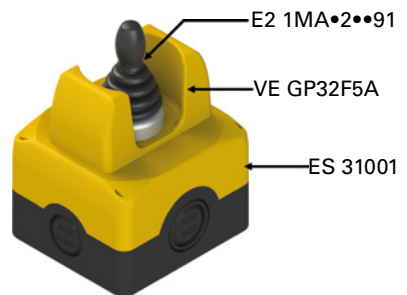
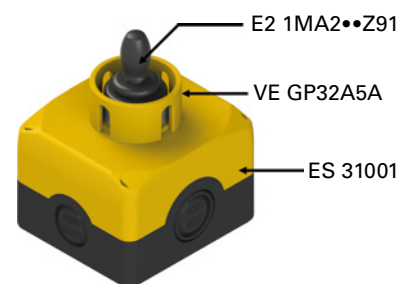

Items with code on **green** background are stock items





General Catalogue  
Detection



General Catalogue  
HMI



General Catalogue  
Safety



General Catalogue  
LIFT



DVD



Web  
[www.pizzato.com](http://www.pizzato.com)



PASSION FOR QUALITY

**Pizzato Elettrica s.r.l.** Via Torino, 1 - 36063 Marostica (VI) Italy  
Phone +39.0424.470.930 - Fax +39.0424.470.955  
E-mail: [info@pizzato.com](mailto:info@pizzato.com) - Web site: [www.pizzato.com](http://www.pizzato.com)

ZE FGL23A16-ENG

